

The Mechanisms of “Construction Grammar”

Author(s): Charles J. Fillmore

Proceedings of the Fourteenth Annual Meeting of the Berkeley Linguistics Society (1988), pp. 35-55

Please see “How to cite” in the online sidebar for full citation information.

Please contact BLS regarding any further use of this work. BLS retains copyright for both print and screen forms of the publication. BLS may be contacted via <http://linguistics.berkeley.edu/bls/>.

The Annual Proceedings of the Berkeley Linguistics Society is published online via [eLanguage](#), the Linguistic Society of America's digital publishing platform.

The Mechanisms of "Construction Grammar"

Charles J. Fillmore
University of California, Berkeley

1. In this paper I will sketch out some of the working parts of a grammatical framework that gives central place to the notion of **grammatical construction**. Rejecting that view of grammar which prides itself in being able to get along without this concept, my colleagues and I have come to believe that, in a framework which takes grammatical constructions as its primary units, not only can we allow the individual constructions in the languages we study to be as complex as they need to be, but we are also able in its terms to recognize powerful generalizations of both language-specific and language-universal sorts.

Unfortunately, the framework I'll be speaking about is a moving target; in fact, it is one of a set of several moving targets with the same name. My goal in this paper is merely to lay out enough of the working assumptions on which I think most of the Berkeley constructionists are agreed, at least in the area of syntax, and to define and display some of the structures and notations which illustrate the application of these assumptions to a small selection of both central and non-central phenomena in the syntax of English.

Not only is Construction Grammar a moving target; so are the theories with which one might compare it. Briefly, construction grammars differ from **transformational grammars** in not having transformations. That is to say, relationships that are presented in transformationalist theories as participating in the derivation of individual sentences, and hence in their structure, are treated instead as relationships defined in the grammar as a whole. [1] Construction grammars differ from **simple phrase-structure grammars** in that the categories that label the units of structure include complex bundles of information, rather than simple atomic categories. Construction grammars differ from phrase-structure grammars which use **complex symbols** and allow the **transmission of information** between lower and higher structural units, in that we allow the direct representation of the required properties of subordinate constituents. (Should it turn out that there are completely general principles for predicting the kinds of information that get transmitted upwards or downwards, this may not be a real difference.) And construction grammars differ from **phrase-structure grammars** in general in allowing an occurring linguistic expression to be seen as simultaneously instantiating more than one grammatical construction at the same level.

While construction **grammars** have similarities to a number of other approaches to grammar, meaning, and natural language understanding, construction **grammarians** differ from many other workers in the generativist tradition by their insistence on simultaneously describing grammatical patterns **and** the semantic and pragmatic purposes to which they are dedicated, and by their tendency to give attention to the fine and fussy details of what might be called the **non-central constructions of a language**. This tendency shows itself, for example, in George Lakoff's detailed survey of constructions in English introduced by the words **HERE** and **THERE** (Lakoff 1987, pp. 462-585); in Knud Lambrecht's studies of the clause types of colloquial French that are used in structuring information (Lambrecht 1986), to which we should now add his contribution to this year's BLS collection; in Paul Kay's studies of scalar and metalinguistic qualifiers in English (Kay 1984, 1988); in the paper by Mary Catherine O'Connor, Paul Kay, and me, on the English **LET ALONE** construction (Fillmore, Kay and O'Connor, 1988); and in a body of work currently in progress on the part of a number of graduate students. [2] Our reasons for concerning ourselves with otherwise neglected domains of grammar are not so that we can be left alone, by claiming territory that nobody else wants, but specifically because we believe that insights into the mechanics of the grammar as a whole can be brought out most clearly by the work of factoring out the constituent elements of the most complex constructions.

2. By **grammatical construction** we mean any syntactic pattern which is assigned one or more conventional functions in a language, together with whatever is linguistically conventionalized about its contribution to the meaning or the use of structures containing it.

On the level of syntax, we distinguish for any construction in a language its **external** and its **internal** properties. In speaking of the **external syntax** of a construction we refer to the properties of the construction as a whole, that is to say, anything speakers know about the construction that is relevant to the larger syntactic contexts in which it is welcome. By the **internal syntax** of a construction we have in mind a description of the construction's make-up. The familiar **phrase-structure rules** can be read off as descriptions of (the syntactic portions of) constructions: the symbol to the left of the rewrite arrow, standing for the category of the whole construction, represents its external syntax, while the sequence of symbols to the right of the rewrite arrow indicates the construction's internal syntax, and it does this by specifying the external categories of the constructions which can serve in given positions within it. The constructions that most hold

our interest, however, are of greater complexity than that of simple phrase-structure sub-trees of depth one.

There are various interchangeable notations for representing linguistic structures in construction grammar. One that I will use is a boxes-within-boxes notation in which information about the external syntactic, semantic and pragmatic requirements of a construction is written in the perimeter of the box, with smaller boxes drawn inside to display the construction's internal syntax. In Figure 1, a category with the xxx value of the attribute aaa has as its two constituents one with the yyy value of attribute bbb and, to its right, one with the zzz value of attribute ccc.

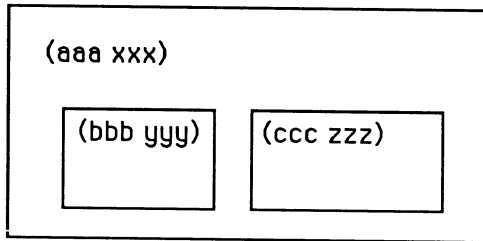

Figure 1

Formally, diagrams of this sort are exactly equivalent to constituent structure diagrams with fancily decorated node labels.

An advantage in using the box notation is that in a step-by-step demonstration of the parsing of a sentence, we can draw boxes around the elements of surface linguistic expressions, allowing us to build up a complex description of a complex expression by showing how it exemplifies the superimposition of construction upon construction.

The grammar of a language can be seen as a repertory of constructions, plus a set of principles which govern the nesting and superimposition of constructions into or upon one another. The generation or analysis of linguistic expressions involves fitting grammatical constructions together in as many ways as possible, allowing them to come together only when they match each other's requirements (or when there's something interesting to say about what happens when they don't), and stopping when every lexical category is occupied by a phonological form, and when every obligatory attribute has been provided with a value. In ways made familiar in all versions of assembling constructions, whenever we can find more than one way of assembling constructions to yield the same expression form, that form is shown to be ambiguous in ways explained by the differences in the contributing constructions. [3]

3. At least some of the grammatical properties of a construction can be given as **feature structure representations**, that is, as sets of **attribute-value pairs**, and can be seen as generally satisfying the requirements of a unification-based system. Since the basic phrasal categories will be selected from a set of fixed and mutually exclusive types, we can represent these by the attribute **category**, abbreviated **cat**, paired with one of the values it accepts, such as **Noun**, **Verb**, **Adjective**, etc.; they will thus be introduced with such formulas as (cat N) or (cat V). We are currently representing the ranks or **levels** of headed constructions in terms of **maximal** and **minimal categories**, where maximal categories fill major structural positions in constructions, and minimal categories are the stored or derived units of the lexicon. We believe that these distinctions give us a way of achieving successfully what is aimed at by the so-called "X-bar theory". Major category units will be expressed as pairs of features of the category and level types. Thus, a maximal nounphrase will be represented as

(cat N) (max +)

whereas a lexical adjective will be represented as

(cat A) (min +)

Maximal categories which are phrases are (max +)(min -); structures which are phrasal but non-maximal are (max -) (min -). There are no incompatibility relations between the level features of maximality and minimality. The abandonment of the notations of X-bar syntax in favor of the separation of features of phrasal maximality and minimality creates the possibility that lexical items which may but need not serve as maximal phrases can be listed as having unspecified maximality, and lexical items which necessarily serve as maximal phrases, such as proper names (when used as proper proper names) and personal pronouns, can be listed as having their maximality feature marked "+". We therefore avoid the need to recognize a name like JOE or a pronoun like SHE as simultaneously an N-zero, an N-bar, and an N-double-bar. Instead of a columnar representation of the categorial nature of the name JOE, as in Figure 2, we will prefer a representation in which JOE is given simultaneously as a word and as a maximal phrase, as seen in Figure 3.



Figure 2

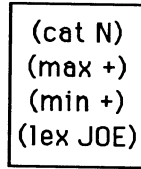

Figure 3

Here JOE is recognized as a lexical item (hence as *min +*) but one whose external syntax is that of a maximal phrase. With names and personal pronouns there are obvious reasons why they are lexical items, and reasons of grammatical behavior why they are maximal nominals; but there is no reason to assign to such words an additional intermediate structural level of the so-called N-bar.

4. Considerations of maximality in nominal expressions lead in a natural way to our first example of a construction: the English **determination construction**, which consists of a maximal noun phrase containing a determiner and a non-maximal nominal head.

Since the "determiner" in a "determiner plus nominal" construction can be any of a variety of categories (that is, it can be an article, a possessive nominal, or a demonstrative), I introduce the term "determiner" as a **role name** rather than as a **category name**. The category of its fillers can be left unmentioned. Articles will be marked in the lexicon as necessarily having the determiner role, demonstratives and instances of the possessive construction will be described in a way that shows them capable of filling the determiner slot. The construction will look something like what is shown in Figure 4:

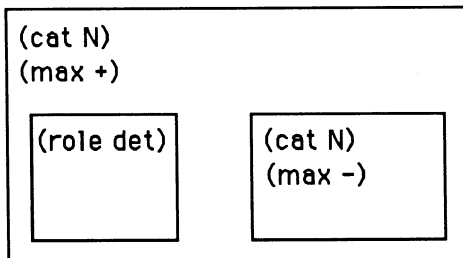

Figure 4

This diagram states that the combination of a determiner with, to its right, a non-maximal nominal, counts as a maximal nounphrase. A pronoun or a proper name will not fit the second slot in this construction because it would be marked with maximality value "+", and what is required here is maximality value "-"; a mass noun will fit it because with a mass noun the maximality value is left unspecified; a singular count noun will fit it because a count noun is marked with maximality value "-". Thus:

proper noun:	(cat N)(max +)
mass noun:	(cat N)(max)
singular count noun:	(cat N)(max -)

(We will naturally need to include a mechanism in the morphology for de-marking count nouns when they are made plural, as well as mechanisms for recognizing that both mass nouns and proper nouns have special uses in which they exhibit the syntax of count nouns.)

It is now necessary to modify my earlier statement that maximal phrases fill major structural positions in sentences. English has various constructions requiring non-maximal nominals, that is, lexical or phrasal nominals that would need a determiner in order to appear in true argument position in a clause. One of these is the **Unique-Role Nominal Predicate Construction**, exemplified by sentences like I WAS CHAIRMAN OF THE COMMITTEE, SHE IS CHIEF SURGEON TO THE ROYAL FAMILY, YOU ARE NOW PRESIDENT OF THE CLUB, and so on. (The semantics of "unique role" is suggested by the unacceptability of *SHE IS MEMBER OF THE CLUB; the inability of a non-maximal phrase to occur in "argument" position is shown by the unacceptability of *PRESIDENT OF THE CLUB RESIGNED.) Another construction allowing a non-maximal nominal is **Fronting to That**, as in

subordinate clauses like FOOLISH CHILD THAT I WAS. (Compare *I WAS FOOLISH CHILD.) These are both cases in which a nominal predicate is a count-noun, or a modified count-noun-headed phrase, in which the "obligatory" determiner is missing.

5. The **Determination Construction** just exemplified can be used to illustrate the **unification** process, and the manner in which entities can not only satisfy the requirements of structural positions in a construction but can bring to a construction properties and requirements of their own.

It may be useful to think of the positions within a construction as **offices** (for example, political offices). The obligatory features associated with positions in the description of the construction can be thought of as the **qualifications** for the office, and the role indicator identifies the **function** of the office. This much involves the **institution** within which the office has a role, independently of any specific **candidate** or **incumbent**. A candidate which does not satisfy the qualifications of the office cannot fill the office. When a particular **incumbent** occupies the office, that incumbent has properties of its own, not only the properties which allowed it to occupy the office, but also properties which cause it to make its own demands. The way in which an obligatorily transitive verb brings into the office of verbal predicate the requirement of finding room for a direct object can be compared with the way in which a married male incumbent in the office of President of the United States brings with it the not always welcome additional role and office of the First Lady.

If the determiner brought into the determination construction is the plural demonstrative **THESE**, and the head noun is the mass noun **BUTTER**, the combination, ***THESE BUTTER**, will not work, because the features of **number**, singular and plural, as well as the features of **configuration**, count and mass, will clash. **THESE** requires that the office next door be occupied by a plural noun. This means that we need devices which provide for the contribution of each constituent element to the description of the external syntax of the whole: such a device will identify those properties of incumbents which become properties of the office as occupied by that incumbent. It is obviously important for a maximal nominal to be recognized as singular or plural, for reasons of verb agreement, and as definite or indefinite, establishing its qualification for inclusion in certain of the existential sentence constructions. Thus, number and definiteness, whether brought in as the requirements of determiners or of nouns, will become properties of the maximal noun phrase as well. (The recognition of the need to do this is in no way a unique feature of Construction Grammar.)

6. The lexicon, which in important ways is not distinct from the repertory of constructions, associates with each lexical item, explicitly or implicitly, information about the grammatical constructions in which the item can participate. To the extent that a given lexical item is closely tied to one or more specific grammatical constructions, describing that item is equivalent to describing the constructions in which it participates. Thus, in Paul Kay's (unpublished) construction grammar treatment of complex English kin-terms, the word REMOVED, as it appears in such phraseological units as **second cousin once removed**, is included as a lexically specified part of the construction itself. This is in contrast to an absurd view according to which the active verb REMOVE would have to be described in such a way that, when it occurs as a postnominal modifier of the word COUSIN, in a past-participial form qualified by an ordinal number, it just happens to contribute the right meaning to the complex phrase.

In those cases in which generalizations about lexical items can be made without reference to particular constructions, the combinatorial properties of lexical items can be stated as their **valence descriptions**. The valence description of a complement-taking predicator can be thought of as the staffing demands which a particular incumbent brings to an office. The valence description of a word identifies its grammatical and semantic complements (including the subject), showing, for each of these, wherever full specification is called for, its grammatical function, its semantic role, and its morpho-syntactic marking. There are numerous redundancy relations among these, suggesting that much of the information displayed in Figure 5 (offered as a partial lexical description of the English verb GIVE) is predictable from other information; the figure shows the structure when all the predictable features are filled in. (The labels on the rows distinguish Grammatical Function (GF), Semantic Role (SR), and Morphosyntax (MS) of the predicator's complements.

(cat V)			
(min +)			
(lexeme GIVE)			
valence			
GF:	subject	object	complement
SR:	agent	patient	recipient
MS:	N	N	P[to]

Figure 5

The semantic information associated with a lexical item, about which I unfortunately have nothing to say in this paper, does its work in part by providing an indicator of the **semantic frame** with which the item is associated. The **semantic role array** in the valence description (what I used to call the **case frame**), identifies the elements which are foregrounded ("profiled", to use Ron Langacker's term) within such a frame. We will often find that information about the syntactic requirements of a lexical item can be read off from, or at least motivated by, the associated semantic frame. The semantic interpretation of the sentence will be accomplished by unifying, or otherwise integrating, semantic information from the semantic frames activated by the predicator with those introduced by the obligatory and optional companions (the complements and adjuncts) of the predicators.

7. I introduced the word **subject** as the name of a grammatical function or role specified in a predicator's valence description. We need to distinguish two notions of "subject" in this discussion: (1) the subject argument of a predicator, typically the argument associated with the highest-ranking semantic role, and (2) the subject of a finite sentence. I shall refer to these as the **P-subject** and the **S-subject**, respectively. In simple sentences, the P-subject and the S-subject are the same.

The **subject predicate construction**, of English and many other languages, is, in common with the determination construction already discussed, a construction which deals with the maximality value of a category, at least in the treatment that is being proposed here. I treat a clause or sentence as a maximal verb-headed phrase. Figure 6, displaying one of the constructions for defining the S-subject in English, shows that something capable of filling the role "subject", united with a non-maximal verbal, yields a maximal verb phrase, on condition that the unit as a whole (and hence its head verb) is **finite** (hence the "(infl tense)").

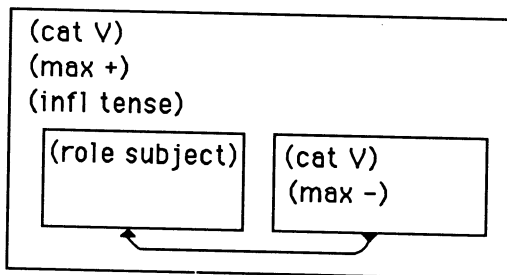

Figure 6

The arrow connecting the two boxes indicates that the constituent in the left box is available as an instantiation of the P-subject requirement of the head verb of the verb phrase in the second box. Whatever other requirements the verb has must be satisfied elsewhere, for example, inside the verb-phrase box. In those cases in which no P-subject is assigned to the verb which heads the verb-phrase, either directly or by a process to be described shortly, the language provides a way of filling this first slot anyway -- for example, with the word IT.

It should be noticed that the S-subject is not given a category specification, in the same way that the determiner in the determination construction lacks a category specification. It will have whatever category is required of the P-subject of the head verb in the verb phrase. This means, of course, that we do not need to treat infinitives, THAT-clauses, interrogative clauses, preposition phrases, etc., as NPs just when they appear as the subjects of sentences.

The construction just observed is not the only means of introducing an S-subject. An **inversion** variant of a maximal V-phrase, has a finite auxiliary verb in initial position, the subject following and the complements of the auxiliary appearing after that, as suggested by Figure 7. The example here is simplified, covering the case where the auxiliary requires only one non-subject complement. (I am here making the common assumption that auxiliaries are raising verbs, and that the copula BE for these purposes is a member of the class of auxiliaries.)

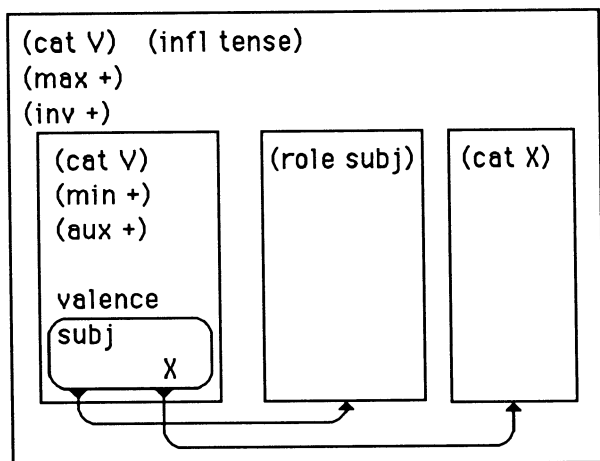

Figure 7

The feature "inversion" is a part of the external syntax of the construction. What we have here, by the way, is a variety of **polarity item**. This construction can be selected when the clause as a whole has the feature of interrogation (as in yes-no questions), or when it is in the scope of negation (as when it follows a negative word like NEVER and SELDOM), or when it is, as a whole, the antecedent of a counterfactual conditional sentence (as in WERE SHE HERE, HAD I KNOWN, etc.).

8. A V- ("V minus") phrase, a phrase of the type (cat V)(max -), consists of a lexical verb together with some or all of its non-subject complements or augments. I say "some or all" because some of them may be present at some distance from the V- constituent, just in case it is in topic or WH-phrase position. A non-maximal verb phrase built around the verb REMOVE, and incorporating all of its local, i.e., non-subject complements, is illustrated in Figure 8.

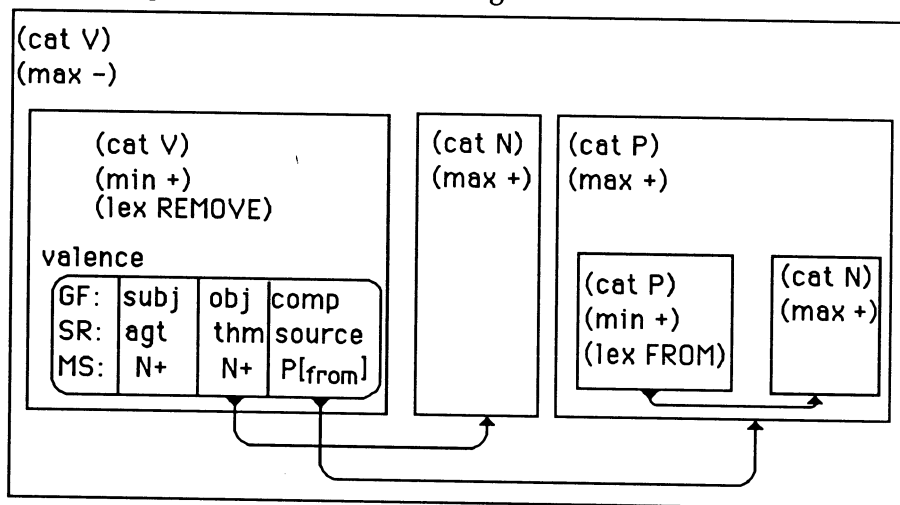

Figure 8

Again, the arrows are instantiation links, showing that certain of the "staffing needs" of the verb have been met inside the verb phrase. In addition to the obligatory complements of a predicator, other phrasal elements may be introduced into a verb-phrase as long as they contribute meanings which integrate into the semantic frame built up around the predicator, or can fit the semantic frame of the predicator into their own semantic frames. They differ from complements in not being syntactically required.

Under certain conditions, complements may be missing. In languages in which there are lexically specifiable conditions on the omissibility or optionality of complements, information about such omissibility will be included with some system of diacritics on particular complement descriptions, as suggested in Figure 9, something along the lines of Fillmore 1969 and Fillmore 1985. Here, parentheses represent omissibility under conditions allowing an "indefinite interpretation", square brackets representing omissibility under conditions of conversational givenness. (In this notation, I follow Allerton 1975.) That this is not a simple matter of lexical marking was forcefully argued in Sally Rice's paper elsewhere in this volume.

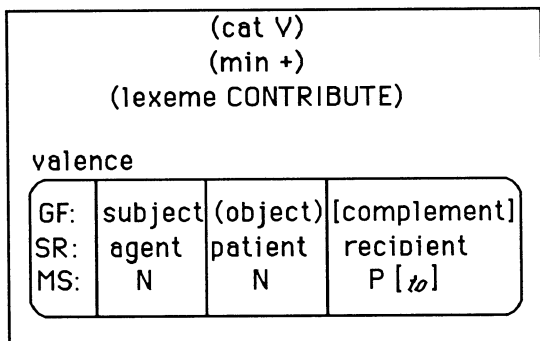

Figure 9

9. The subject argument of a verbal predicate can be instantiated in the subject position in the subject-predicate construction; non-subject arguments can be instantiated inside the verb phrase, as we have seen. There are additional means of cashing out the argument requirements of a predicate, among them various sorts of **left isolate** constructions. A left-isolate which is an interrogative word occurs in the construction suggested by Figure 10, where the arrow is interpreted as meaning that the left-isolated constituent complements or augments the semantic structure in the predication to its right. The result of the union of the WH-element with its partner to the right is a complete clause, that is, a maximal verb-headed constituent.

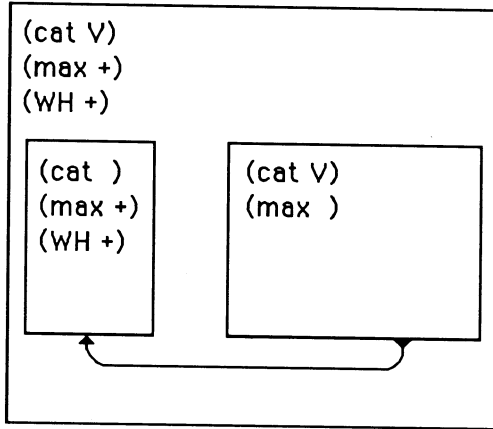

Figure 10

Notice that the maximality of the verbal constituent is not indicated; what this means is that if the interrogated element is the subject, then the structure fits the structure of the subject predicate construction as well, and the sister constituent is a "verb phrase" ("V-") rather than a "sentence" ("V+"). If, however, the verbal category is maximal, then the instantiation link is to some non-subject inside the sister constituent. The link will mean that the fronted element must be unified with the valence description of some predicate inside the sister constituent. [4] When the second constituent is V+, it will have the feature "inversion" (and the structure shown in Figure 7) just in case the sentence is a main-clause question.

10. Control relationships are coded into valence descriptions, and represented in diagrams with links that we call **co-instantiation** links. These link an argument requirement in one predicate with an argument requirement in a "higher" or "commanding" predicate, and assert that in whatever way the argument of the higher predicate gets realized, it simultaneously satisfies the argument requirement of the predicate with which it is linked. Omitting the details here, suffice it to say that the difference between coinstantiation of the type usually called **Raising** and that usually called **Equi** has to do with whether or not the coinstantiating argument has a semantic role assigned to it. Co-instantiation indices are of the familiar types: **S(S)** means that the subject role of the commanding predicate coinstantiates the subject role of the complement; **O(S)** means that the direct object of the commanding predicate coinstantiates the subject role of the

complement; **S(X)** means that the subject of the commanding predicate coinstantiates a non-subject; and **S()** means that the subject of the commanding predicate coinstantiates either the subject or a non-subject of the complement. A simple example, using the adjective **WORTH**, is presented in Figure 11. **WORTH** is here described in that usage by which it requires a gerundial local complement, and by which it co-instantiates with its subject a non-subject of that gerund. To get a sentence like **SHE SEEMS WORTH KNOWING**, we have to notice that the subject of **KNOW** is taken as generic; the object of **KNOW** is coinstantiated with the subject of **WORTH**; and the subject of **WORTH** is coinstantiated with the subject of the copula. (Instantiation links are marked "I", co-instantiation links as "CI".)

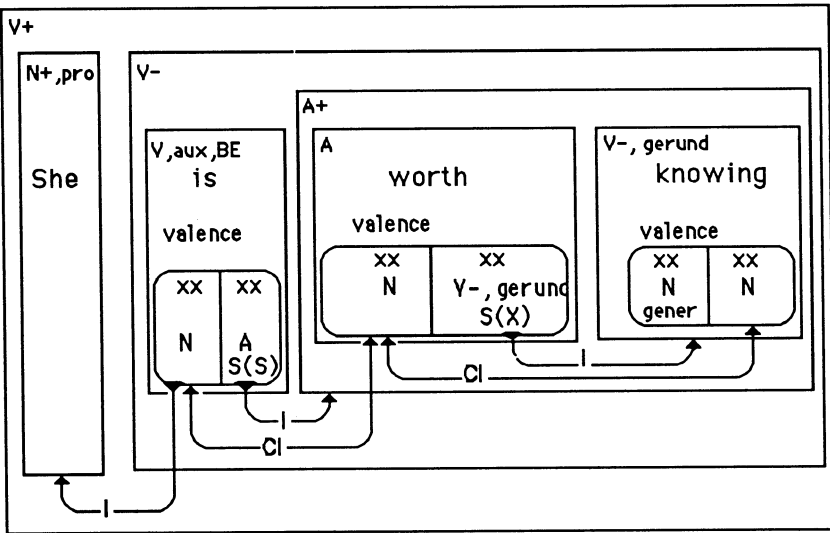

Figure 11

11. In addition to links of instantiation and co-instantiation, there are also links of necessary coreference which characterize certain constructions. A simple example, shown in Figure 12, is the phraseological unit **DO ONE'S BEST**. Here the requirement is that the possessive nominal prefixed to the word **BEST** must be coreferential to the subject of the verb. That means that the pronominal form must match that of the P-subject of **DO ONE'S BEST**. (I did my best, she did her best, etc.) That is to say, however the P-subject of **DO ONE'S BEST** in this construction gets realized - by being directly instantiated in a subject-predicate construction, by being co-instantiated by the subject of

the verb TRY, the object of the verb PERSUADE, or whatever, that entity must unify with the possessive pronoun inside this construction. (Just in case this element is inside a construction which causes its subject to be given the generic or "arbitrary" interpretation, the possessive form will be the word ONE'S.)

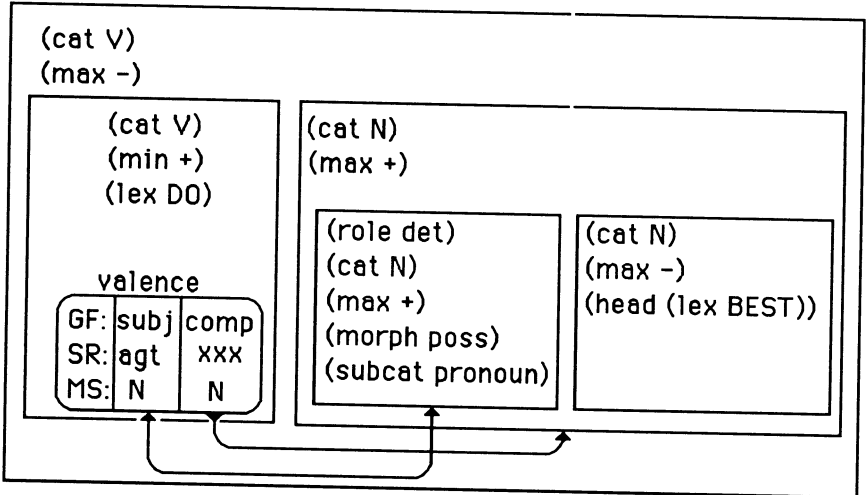

Figure 12

12. Because of the nature of the English inflectional system, the fitting together of lexical verbs with the subject-predicate construction forces us to recognize another necessary property of English grammar. We need to distinguish inflectional forms from lexemes, and we need to associate with inflectional forms whatever special requirements they impose. To show the difference, we might compare a valence description of the verb HAVE in what we will pretend to be its simple 'possession' sense, with the inflected form /HAS/.

The verb HAVE occurs in a large number of constructions: it functions, for example, as an auxiliary, as a simple transitive verb, and as a complement-taking verb in a number of different contexts. Figure 13 shows its use in indicating simple possession. In each of these constructions, the inflected form HAS can stand in as its representative, as long as certain requirements which it itself imposes are satisfied. Notice the three boxes in Figures 13, 14 and 15.

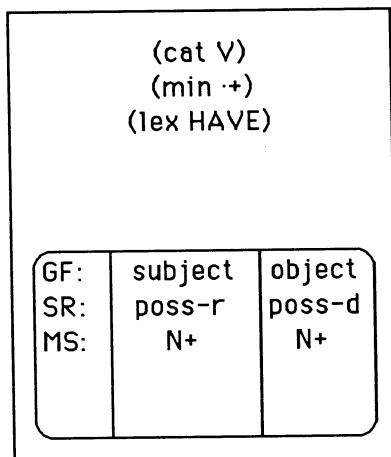

Figure 13

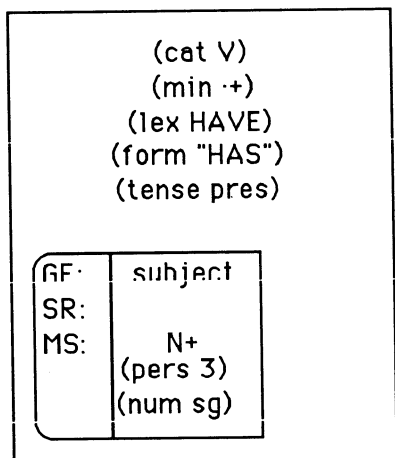

Figure 14

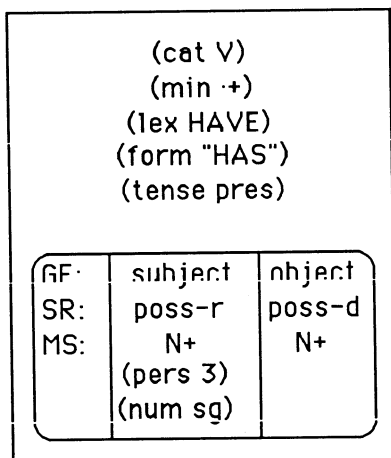

Figure 15

The phonological form HAS, interpreted in Figure 14, is a representation of this verb associated with the present tense, but its standing for any of the instances of the abstract verb HAVE brings with it the requirement that the subject be third person and singular. The lexicon of forms creates or contains entities which must unify with grammatical elements and provide them with phonological forms. The product of this unification can be shown in Figure 15, a superimposition of the information in Figures 13 and 14.

A verb inflected for tense can only occur as the head verb in the subject-predicate construction, and, as we see, it imposes restrictions on the grammatical nature of its subject. In languages in which there is both subject agreement and object agreement, we must be able to describe the morphology as creating forms with associated requirements on their subjects and arguments. The phenomena of "agreement" will thus be merely matters of unification involving the selection of word forms.

In addition to simple unification, we need to have a notion of **obligatorily evaluated attributes**. The attribute given in Figures 14 and 15 as "form" is one of these: every lexical item must have this attribute filled in (possibly, in certain cases, with zero). Morphemes which have allomorphs (and lexemes which have allo-lexes) will generally leave the "form" slot unfilled. The item which brings information filling such a slot will typically bring grammatical requirements of its own, as we have seen with the word HAS.

13. Our grammar needs a way of dealing with the subtle character of contexts which are created or defined by particular grammatical constructions. Positions in the grammatical templates we manipulate are contexts within which special principles obtain determining what can occur in it and how what occurs in it gets construed.

In every grammatical theory much is made of the fact that particular complement-taking lexical items create contexts which welcome or require particular features: the indicative-clause complement of HOPE defines a context for the **futurate present**, the verb DOUBT assigns **negative polarity** to its complement, the verb WISH assigns **subjunctivity** to its complement, etc.

Many grammatical constructions can be shown to have this same context-characterizing property. As a simple example, the syntactic idiom which has the introducers IT'S TIME, IT'S ABOUT TIME, and IT'S HIGH TIME, generally requires that the following indicative clause be past tense in form. (IT'S TIME YOU BRUSHED YOUR TEETH; IT'S HIGH TIME YOU STARTED THINKING ABOUT YOUR FUTURE; IT'S ABOUT TIME YOU DID THAT.)

Mention was already made of a copular sentence in which a non-maximal nounphrase appeared as the nominal predicate, as in SALLY IS PRESIDENT OF THE CLUB. There we saw that the position after BE allowed, atypically, a non-maximal nominal. Another and quite distinct copular sentence is the one used for pointing out referents in the common perceptual world of speaker and hearer, as in such sentences as THIS IS MY TEACHER, THOSE ARE MY NEW

FRIENDS, THAT'S MY OLD CAR. An interesting property of this construction is that the demonstrative pronouns occurring as subjects have a clearly different function and meaning-range here than they have in contexts in which they are the arguments of predicates, and it's an interesting job to try to characterize such contexts. Outside of this **Deictic Presentative** context, THIS or THAT requires construal as a non-human entity. Thus if I ask you, ARE YOU PLANNING TO EAT THAT?, I have said something perfectly ordinary, but if I ask you, ARE YOU PLANNING TO MARRY THAT? I am being insulting. In THAT'S MY UNCLE, THIS IS MY MOTHER, and the like, no such insult is implied.

The conditions on this construction seem to be these: the word THAT appears as the subject of a tensed verb and while it may be the immediate subject of a verb other than BE, it must be the ultimate subject of the verb BE. That is, it must instantiate or co-instantiate the P-subject of BE (as well as that of the predicate nominal), but no other semantic-role bearing position. Thus, THAT SEEMS TO BE MY SON-IN-LAW is all right, but THAT SEEMS TO LIKE YOU isn't. HE'S MY BEST FRIEND and THAT'S MY BEST FRIEND are both normal things to say, but while I REGARD HIM AS MY BEST FRIEND is okay, I REGARD THAT AS MY BEST FRIEND is not. An embedded identificational clause is all right if it's indicative: I THINK THAT'S MY FRIEND is okay, but I CONSIDER THAT TO BE MY FRIEND is not. A striking contrast can be seen in the two otherwise semantically identical sentences: THAT'S MY SON-IN-LAW and THAT MARRIED MY DAUGHTER.

In this construction, the predicate nominal has to be a referring expression. In the one we saw earlier, it had to be instead a name of a unique role. Hence, although it's possible to say THAT'S THE CHAIRMAN OF THE CLUB, it's not possible to say THAT'S CHAIRMAN OF THE CLUB. The construction which allows THAT to refer to a human is not the one which allows the predicate nominal to be non-maximal.

14. A more complex instance of obligatorily assigned values, corresponding to the technical notion of **feature inheritance**, on which I have had something to say in Fillmore 1986, and which McCawley has further discussed during these meetings, is that of what I call the **correlative conditional construction**. [5]

This construction has a number of properties, suggested by Figure 16, which are uniquely linked with it, but many others which are not. Our concern here is in factoring out the numerous other constructions which contribute to the whole package. Some of its

properties can be imported into the description of this construction from the fact that it is a conditional sentence; others from the fact that in two places it is an example of the category comparative; by being a conditional sentence, it is also in the class of subordination constructions (including temporal and conditional clauses) which provide very special ways of treating tense and auxiliary categories. In short, a complex set of qualifications for the "offices" defined for this construction come from numerous sources, yielding a marvelously complex package.

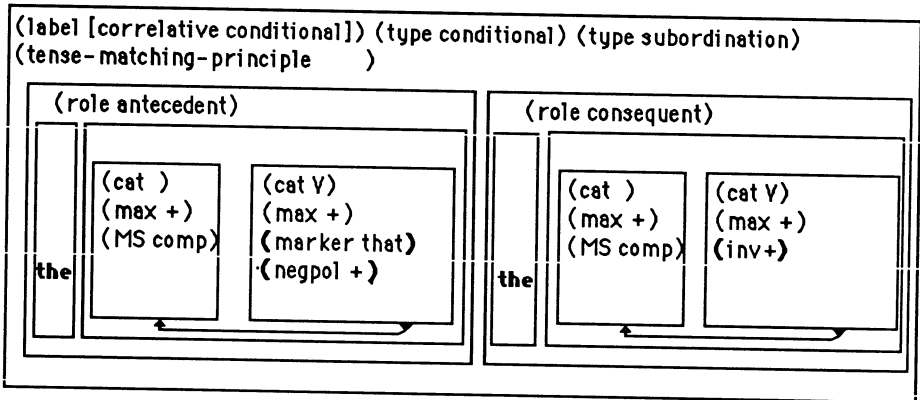

Figure 16

(Certain of the properties of this construction will be "inherited" from others of its properties: that it is an instance of a conditional sentence, that it involves a subordinate-clause/main-clause construction, that the first element of each major piece is of the type "comparative" (indicated with MS comp in the diagram), and so on. We note that the antecedent clause is optionally a negative polarity context, suggested by expressions like *THE MORE YOU DO ANY OF THAT*; that the antecedent clause is optionally introduced by *THAT*, as in *THE LONGER THAT YOU STAY HERE*, and that the consequence clause is an optional "inversion" structure, as in *THE SOONER YOU LEARN HOW TO PRONOUNCE HER NAME, THE MORE LIKELY IS SHE TO GO OUT WITH YOU*. Many of these properties are unique to the correlative conditional construction; many are predicted by, while others are "motivated" by, the membership of this construction in other construction types.)

15. Summarizing, we treat grammatical constructions as syntactic patterns which can fit into each other, impose conditions on each other, and inherit properties from each other. Grammatical constructions define positions which require or welcome fillers with certain properties, and fillers of those positions can introduce constructions of their own and can impose requirements of their own on positions within the constructions which contain them. At least some aspects of the grammar operate on simple principles of unification, augmented by principles of inheritance and principles for checking for the presence of obligatory elements. Since lexical items can be treated as the heads or markers of the grammatical constructions in which they participate, a grammatical formalism can be constructed, we believe, which is built exclusively on grammatical constructions.

NOTES

- 1 This is a point which has been given particular emphasis by George Lakoff. At issue here is, for example, whether in the structure of a **sentence** one needs to represent simultaneously the position out of which a topicalized constituent has been "extracted" or whether in the structure of the **grammar** one needs to show the relationship between topicalized sentences and sentences with all of their constituents "in place".
- 2 There is, of course, a huge body of literature on the functions of specific grammatical constructions, especially in the Generative Semantics tradition, but also in numerous standard reference grammars and pedagogical grammars.
- 3 While I will be speaking mostly of constructions on the level of phrases and clauses, we assume that similar principles are at work in word-formation and in the conventionalized patterns that structure discourse.
- 4 The familiar "Ross constraints" are handled in this theory by characterizing particular constructions as **insulated**, that is, as having impenetrable boundaries with respect to the relations indicated with instantiation arrows; many of the determinants of such insulation appear to be semantic in nature (on which see Lakoff 1986); but that's another story.
- 5 I use the term "correlative conditional" rather than my own earlier term "comparative conditional" for language-comparative purposes: some languages have constructions with essentially the same function as the English one without making use of a "comparative" construction.

REFERENCES

- Allerton, D. J. (1975), "Deletion and pro-form reduction." *Journal of Linguistics* 11.213-238.
- Fillmore, Charles J. (1969), "Types of lexical information." In F. Kiefer, ed., *Studies in Syntax and Semantics (Foundations of Language Supplementary Series Vol. 10)*, pp. 109-137.
- Fillmore, Charles J. (1985), "Pragmatically controlled zero anaphora." *BLS* 12.95-107.
- Fillmore, Charles J. (1986), "Varieties of conditional sentences," *ESCOL (Eastern States Conference on Linguistics)* 3.163-182.
- Fillmore, Charles J., Paul Kay, and Mary Catherine O'Connor (to appear in *Language*), "Idiomaticity and regularity in grammar: the case of *let alone*." (available as Berkeley Cognitive Science Report No. 51).
- Kay, Paul (1984), "The kind of sort of construction", *BLS* 10.157-171.
- Kay, Paul (1988), "Even", Berkeley Cognitive Science Report, No. 50.
- Lakoff, George (1986) "Frame semantics and the coordinate structure constraint," *CLS* 22,
- Lakoff, George (1987), *Women, Fire, and Dangerous Things: What Categories Reveal about the Mind*. University of Chicago Press, Pp. 614.
- Lambrecht, Knud (1986), "Pragmatically motivated syntax: presentational cleft constructions in spoken French." *CLS* 22.